



ACDC12 Solar Air Conditioner Heat Pump

Before installing or using your solar air conditioner, please print and read this manual carefully and keep it for future reference.

Notice To Owner/Installer

This unit is designed for easy installation by an experienced person. It is legal for a homeowner to install it, however we highly recommend using a licensed HVAC technician for installation.

Legal Information About Self-Installing R410A Air Conditioners

Can a homeowner install this system?

Yes, a homeowner with a vacuum pump, proper training, and equipment can install this unit. Unless you are experienced with installing air conditioners we recommend you hire a professional installer. The person who installs the system must do all work in compliance with local building and electrical codes.

Are there any restrictions on the purchase of R410A refrigerants?

R410a is not an ozone-depleting substance. At this time the purchase of R410a refrigerant is not restricted in the US. There is no technician certification requirement for those that purchase HFC refrigerants, such as R-410a or R-134a. If you are not licensed, some local HVAC supply companies may refuse to sell you R410a based on a misunderstanding of the law, or because they wish to discourage homeowners from working on their own systems.

Are there any restrictions on the use of R410A refrigerants?

Yes, it is illegal to knowingly vent or release these refrigerants. The venting prohibition applies to R410a, and all other HFC refrigerants, just as it does for ozone-depleting refrigerants like R-22.

Is EPA technician certification required to service R410A systems?

No, at this time EPA technician certification is not required in order to service R-410a systems.

Source: http://www.epa.gov/ozone/title6/phaseout/technicians_contractors_faq.html

Please read this installation manual completely before installing the product. If the power cord is damaged, replacement must be performed by authorized personnel only. Installation work must be performed in accordance with the NEC and local codes. You should contact a licensed service technician for installation, repair, or maintenance.

Improper installation could damage the system and/or void the warranty and could result in injury, death, or property damage.

CONTENTS

SAFETY PRECAUTIONS

Warning	2
Caution	2
Selecting installation location	3
Accessories	4
Indoor unit installation	5
Outdoor unit installation	7
Refrigerant pipe connection	8
Electrical work	9
Installation of the solar photovoltaic system	12
Evacuation with a vacuum pump	23
Safety and leakage check	24
Testing	25

Please Print & Read This Manual

Inside you will find many helpful hints on how to install and test the air conditioner properly.



CAUTION

- Contact an authorized service technician for repair or maintenance of this unit.
- Only allow a qualified person to install this unit.
- The air conditioner is not intended for use by young children without supervision.
- Young children should be supervised to ensure that they do not play with the air conditioner.
- If the power cord is to be replaced, replacement work must be performed by authorized personnel only.
- Installation work must be performed in accordance with local building and electrical codes.

SAFETY PRECAUTIONS





- Read the follow SAFETY PRECAUTIONS carefully before installation.
- Electrical work must be installed by a licensed electrician. Be sure to use the correct rating and main circuit for the model to be installed.
- Incorrect installation may cause injury, death, or damage.

■ Please pay attention to the following indications.

 WARNING	This symbol indicates the possibility of death or serious injury.
 CAUTION	This symbol indicates the possibility of injury or damage to property.

■ The items to be followed are classified by the symbols:

	Symbol denotes item that is PROHIBITED
---	--

 WARNING	
1) Engage a properly trained person for installation. If installation is defective, you may experience water damage, electrical shock, or fire.	
2) Install according to these installation instructions. If installation is defective, you may experience water damage, electrical shock, or fire.	
3) Use the included accessories and specified parts for installation.	
4) Select a proper location for the indoor and outdoor unit make sure the location can support the weight of the unit.	
5) For electrical work, follow the local electrical codes and these installation instructions. Use a dedicated circuit. If electrical circuit capacity or electrical work is not proper, it can cause electrical shock or fire.	
6) Use the specified cable and connect tightly, clamping the cable so that the cable cannot come loose. A loose connection may cause sparks, overheating, fire, or damage the system.	
7) Wiring routing must be properly arranged so that control board cover is fixed properly. If control board cover is not fixed properly, it will cause heat-up at connection point of terminal causing fire or electrical shock.	
8) When installing the refrigerant tubing connection, make sure not to let any substances other than the specified refrigerant go into refrigeration tube. Otherwise, it may cause lower capacity, abnormally high pressure in the refrigeration cycle, explosion, or injury.	
9) Do not modify the length of the power supply cord or use of extension cord, and do not share the circuit with other electrical appliances.	
 CAUTION	
1) This equipment must be grounded and should be installed with GFCI breaker. It may cause electrical shock if grounding is not absolute.	
2) Do not install the unit in a location where leakage of flammable gas may occur.	
3) Install drainage line described in the installation instructions. If drainage is not proper, water may accumulate and cause damage.	

INSTALLATION INSTRUCTIONS

Selecting installation location

Select an installation location which is rigid and strong enough to support or hold the unit, and select a location for easy maintenance. Read completely, then follow step by step.

Indoor unit

- Do not expose the indoor unit to heat or steam.
- Select a place where there are no obstacles in front of or around the unit.
- Make sure that condensation drainage tube can be conveniently routed away.
- Do not install near a doorway.
- Ensure the spaces indicated by arrows from the wall, ceiling or other obstacles.
- A place where noise prevention is taken into consideration.
- Min. 3 ft. from TV or electronic instrument.
- There should not be any direct sunlight on the indoor unit, sunlight may fade the color of the unit.

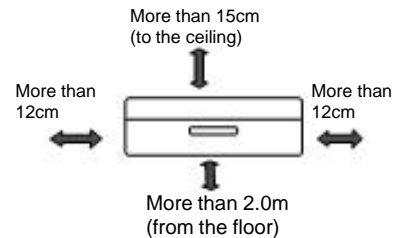

Fig.1

Outdoor unit

- If an awning is built over the outdoor unit it must be done in a way that does not block air flow to the unit.
- Keep the spaces indicated by arrows from wall or other obstacles.
- Do not place animals and plants in the path of the air inlet or outlet.
- Take the air conditioner weight into account and select a place where noise, vibration, and hot air discharged will not be an issue.
- Do not install in a location exposed to flammable gas.
- Do not install high frequency machines such as a welding machine near the air conditioner.

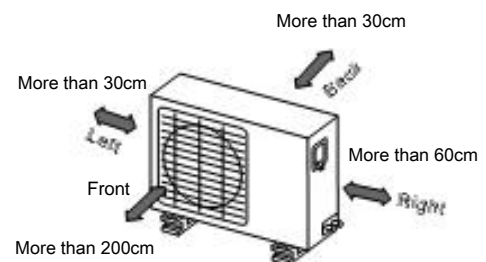

Fig.2

Rooftop installation:

- If the outdoor unit is installed on a roof structure, be sure to level the unit.
- Ensure the roof structure and anchoring method are adequate for the unit location. Consult local codes regarding rooftop mounting.

Recommended Tools For Installation:

Level gauge	Hex Wrench 4mm
Screwdriver	Leak Detector
Electric Drill	Vacuum pump
Hole Saw Bit	Gauge manifold
Flaring Tool	Users manual
Torque Wrench	Thermometer
Adjustable Wrench	Multi-meter
Tape Measure	Pipe Cutter

INSTALLATION INSTRUCTIONS

Accessories

Number	Name of Accessories		Q-ty
1	Installation Plate		1
2	Plastic Expansion Sheath		5-8 (depending on models)
3	Self-tapping Screw A ST3.9X25		5-8 (depending on models)
4	Seal		1
5	Drain		1
6	Connecting Pipe Assembly	Liquid side	Parts you must purchase. Consult the technician for the proper pipe size.
		Gas side	
7	Remote controller		1
8	Self-tapping Screw B ST2.9X10	Optional parts	2
9	Remote controller holder		1

CAUTION

- Use a stud finder to locate studs to prevent unnecessary damage to the wall.
- A minimum pipe run of 3 meters is required to minimize vibration & excessive noise.
- Two of the A, B and C directions should be free from obstructions (see fig. 3).

This illustration is for explanation purposes only. Copper lines must be insulated independently.

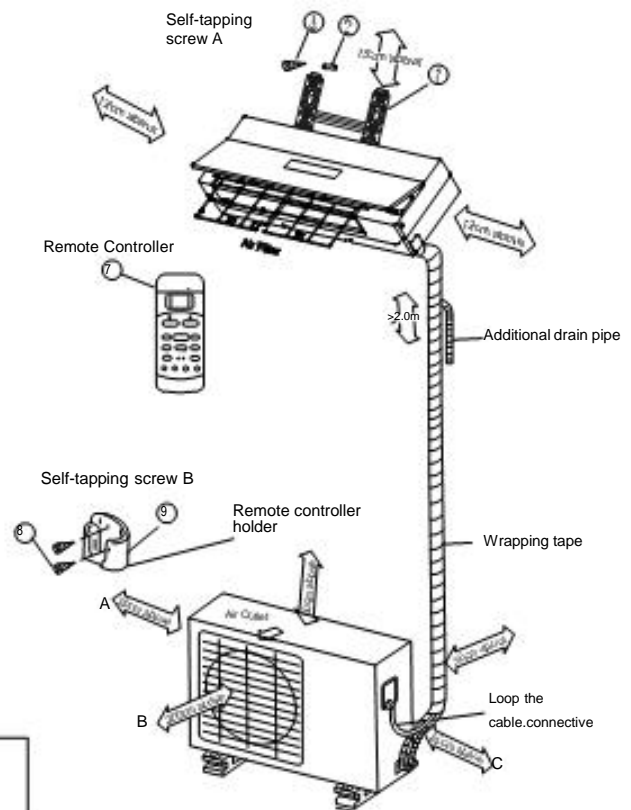

Fig.3

INSTALLATION INSTRUCTIONS

Indoor unit installation

1. Fit the installation plate horizontally on structural parts of the wall with spaces around the installation plate.
2. If the wall is made of brick, concrete, or the like, use #8 anchor screws of the appropriate size.
3. Fit the installation plate on the wall with eight (8) anchor screws.

Correct orientation
of Installation Plate



Fig.4

Note:

Fit the installation plate and drill holes in the wall according to the wall structure and corresponding mounting points on the installation plate. The installation plate is different according to the models.

(Dimensions are in "mm" unless otherwise stated)

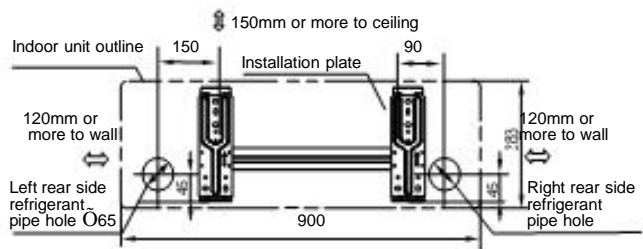

Fig.5

Drill a hole in the wall

1. Determine hole positions according to the diagram detailed in Fig.5. Drill one (1) hole (2 1/2") slanting slightly to outdoor side.
2. Always use wall hole conduit when drilling metal grid, metal plate, or the like.

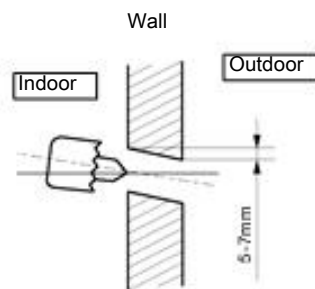

Fig.6

INSTALLATION INSTRUCTIONS

Connective Tube and Drainage Installation

1. Run the drain hose sloping downward. Do not install the drain hose as illustrated in Fig.7.
2. When connecting extension drain hose, insulate the connecting part of extension drain hose with a shield pipe, do not let the drain hose slack.

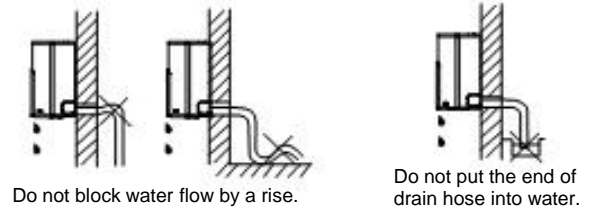

Fig.7

Refrigerant Tube Installation

IMPORTANT:

The unit can only use right-hand piping or right rear piping as shown in Fig.8.

1. Remove the cover for right-hand piping first.
2. For the right rear piping, install the piping as shown in fig. 8
3. Fix the end of the connective pipe. (Refer to Tightening Connection in REFRIGERANT PIPING CONNECTION)

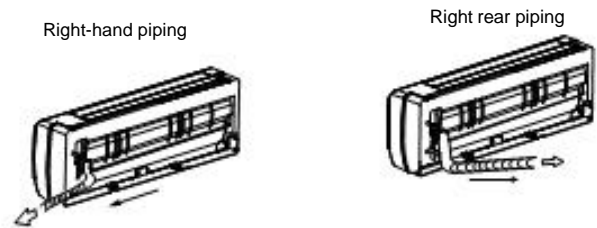

Fig.8

Indoor unit installation

1. Pass the piping through the hole in the wall.
2. Put the upper claw at the back of the indoor unit on the upper hook of the installation plate, move the indoor unit from side to side to see that it is securely hooked (see Fig.9 & Fig.10).
3. Piping can easily be made by lifting the indoor unit with a cushioning material between the indoor unit and the wall. Remove material after it is not needed.
4. Push the lower part of the indoor unit up on the wall, then move the indoor unit from side to side, up and down to check if it is hooked securely.

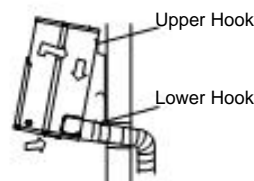

Fig.9

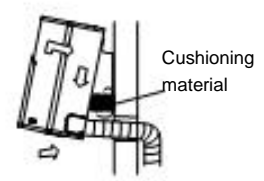

Fig.10

INSTALLATION INSTRUCTIONS

Piping and wrapping

Bundle the tubing, connecting cable, and drain hose with tape securely, evenly as shown in Fig.11

- Because the condensed water from rear of the indoor unit is collected in the drain pan to be piped out of room, do not put anything else in the drain pan.

CAUTION

- Connect the indoor unit first, then the outdoor unit.
- Do not allow the piping to drain out from the back of the indoor unit.
- Be careful not to let the drain hose slack.
- Make sure to insulate the tubing.
- Be sure that the drain hose is located at the lowest side of the bundle. Locating at the upper side can cause drain pan to overflow inside the unit.
- Never wrap the power wire along with control cable.
- Run the drain hose sloped downward to drain out the condensed water smoothly.

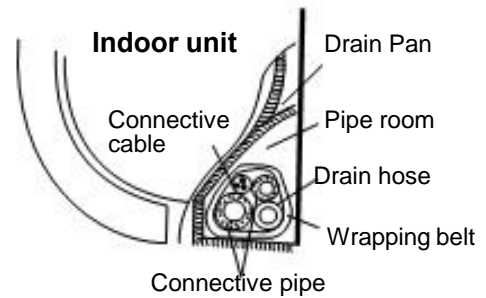

Fig.11

Outdoor Unit Installation

- Install the outdoor unit on a rigid base to prevent increasing noise level and vibration.
- Determine the air outlet direction where the discharged air is not blocked. In the case that the installation site is exposed to strong wind, make sure the fan is operating properly by putting the unit lengthwise along the wall or using a dust or shield plates.
- Especially in windy area, install the unit to prevent the admission of wind. If using a suspending installation, the installation bracket should Follow the technique required in the installation bracket diagram.
- The installation wall should be solid brick, concrete or the same intensity construction, or actions to reinforce, damping supporting should be taken. The connection between bracket and wall, bracket and the air conditioner should be firm, stable and reliable.
- Be sure there are no obstacles which block air flow.

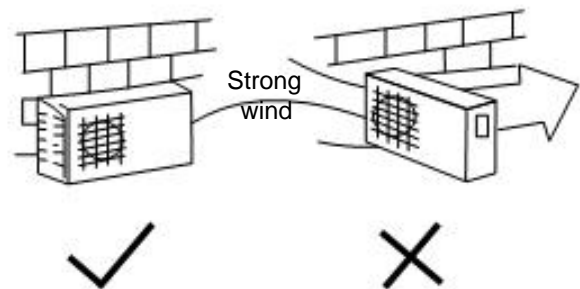

Fig.12

REFRIGERANT TUBE CONNECTION

Placement of outdoor unit

- Anchor the outdoor unit with bolts and nuts on a concrete or rigid mount.

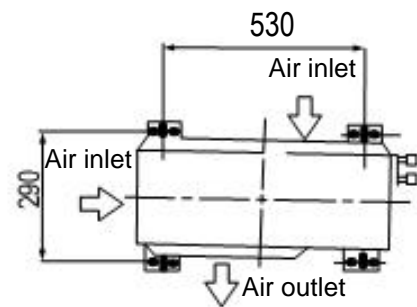

Fig.13

Drain Joint Installation

- If a drain elbow is used, the unit should be placed on a stand which is taller than 1.5”.
- Fit the seal into the drain elbow, then insert the drain joint into the base pan hole of the outdoor unit, rotate 90 degrees to securely assemble. Connect the drain joint with the extension drain hose (locally purchased), to allow the water to drain from the outdoor unit during heating mode.

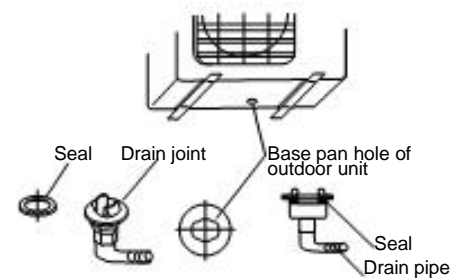

Fig.14

Refrigerant Tube Connection

1. Flaring work

Main cause for refrigerant leakage is due to defect in the flaring work. Carry out correct flaring work using the following procedure:

A: Cut the pipes and the cable.

1. Use the piping kit accessory or pipes purchased locally.
2. Measure the distance between the indoor and the outdoor unit.
3. Cut the pipes a little longer than the measured distance.
4. Cut the cable 60” longer than the pipe length.

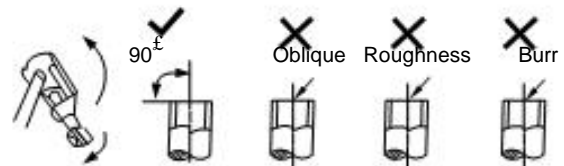

Fig.15

B: Burr removal

1. Completely remove all burrs from the cut cross section of pipe/tube.
2. Put the end of the copper tube/pipe in a downward direction as you remove burrs in order to avoid dropping burrs into the tubing.

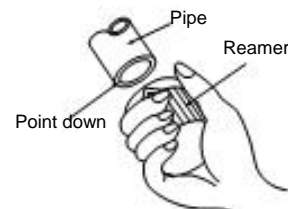

Fig.16

ELECTRICAL WORK

C: Putting Nut On

Remove flare nuts attached to indoor and outdoor unit, then put them on pipe/tube having completed burr removal.(not possible to put them on after flaring work)

D: Flaring Work

Firmly hold copper pipe in a die in the dimension shown in the table below.

Outer diam. (mm)	A(mm)	
	Max.	Min.
φ 6.35	1.3	0.7
φ 9.52	1.6	1.0
φ 12.7	1.8	1.0

Tightening Connection

- Align the center of the pipes.
- Sufficiently tighten the flare nut with fingers, and then tighten it with a wrench and torque wrench as shown in Fig.20 & 21.

Outer Diam.	Torque	Additional Torque
1/4"	11.06 Ft. Lbs.	11.8 Ft. Lbs.
3/8"	18.44 Ft. Lbs.	19.18 Ft. Lbs.
1/2"	25.80 Ft. Lbs.	26.55 Ft. Lbs.

Caution

- Excessive torque can break the nut.

Electrical Work

Electric safety regulations for the initial Installation

1. If there is an unsafe power supply, the technician should refuse to install the air conditioner and explain to the client what the problem is.
2. Power voltage should be in the range of 90%~110% of rated voltage.
3. The GFCI protector and main power switch with a 1.5 times capacity of Max. Current of the unit should be installed.
4. Ensure the air conditioner is grounded well.
5. Refer to the Electrical Connection Diagram located on the panel of the outdoor unit to connect wires.
6. All wiring must comply with local and national electrical codes and be installed by licensed electricians.
7. An individual branch circuit and single receptacle used only for this air conditioner must be available. See the following table for suggested wire sizes and fuse specifications:

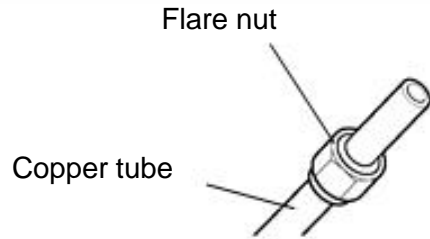

Fig.17

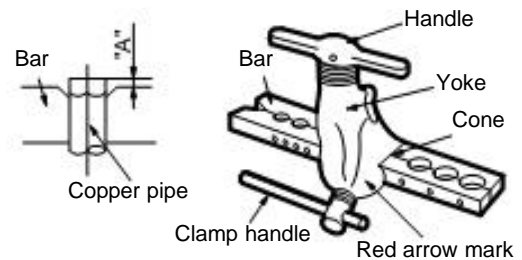

Fig.18

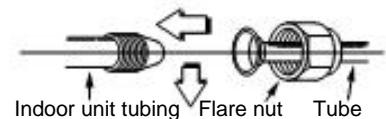

Fig.19

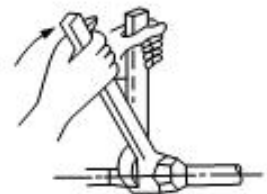

Fig.20

ELECTRICAL WORK

Minimum nominal cross-sectional area of conductors:

Rated current of appliance (A)	Nominal cross-sectional area (mm)
>3 and <6	.75
>6 and <10	1.0
>10 and <16	1.5
>16 and <25	2.5

NOTE: The cable size and the current of the fuse or switch are determined by the maximum current indicated on the nameplate which is located on the side panel of the unit. Please refer to the nameplate before selecting the cable, fuse and disconnect.

Connect the cable to the indoor unit

NOTE: Before performing any electrical work, turn off the main power to the system.

1. The front panel should be removed before connecting the cable between inside and outside.
2. Push the front panel up straight, then open it to an angle of 20 degrees (Fig.21 & 22). To take down the front panel, you should first release the two lock levers on the back of the panel (Fig.23), Then lift it upward.
3. Release the coupler plugs connected with the front display panel as shown in Fig.24.
4. After taking down the front panel, remove the electrical box cover by loosening the screw as shown in Fig.25.
5. Connecting cable between indoor unit and outdoor unit shall be approved neoprene sheathed flexible cord, type designation H07RN-F or heavier cord. Ensure the color of wires of outdoor unit and the terminal Nos. are the same to the indoors respectively, Fig.27.
6. Wrap the cables not connected with terminals with insulation tape so that they will not touch any electrical components. Secure the cable onto the control board with the cord clamp. Connect the coupler plugs connected with the front display panel.

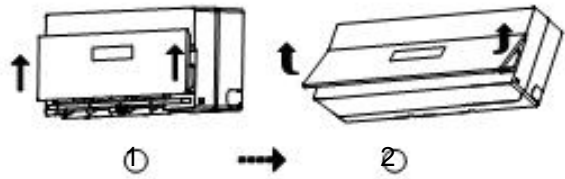

Fig.21

Fig.22

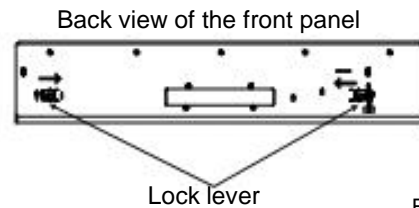

Fig.23

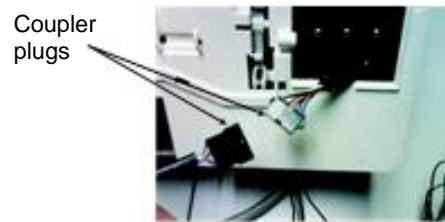

Fig.24

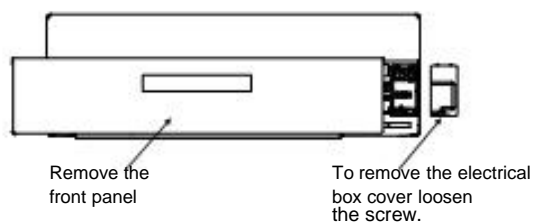

Fig.25

7. Reinstall the electrical box cover, keep the white band just under the groove as shown in Fig. 26a and curve the cable into the groove. Make sure the cable connected with LED display window is fixed by the electrical box cover after installation, Fig.26b.

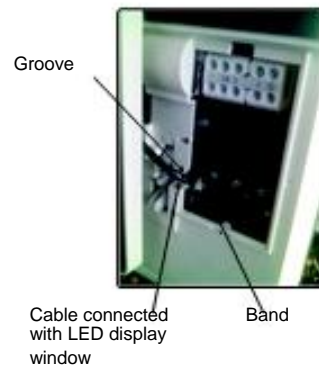

Fig.26a



Fig.26b

Connect the cable to the outdoor unit

1. Remove the electrical control board cover from the outdoor unit by loosening the screw as shown in Fig.28.
2. Connect the cables to the terminals as identified with their respective locations, see figure 27.
3. Secure the cable onto the control board with the cord clamp.
4. To prevent the ingress of water, form a loop of the connective cable as illustrated in the installation diagram of indoor and outdoor units.
5. Insulate unused cords (conductors) with PVC-tape, so they do not touch any electrical or metal parts.

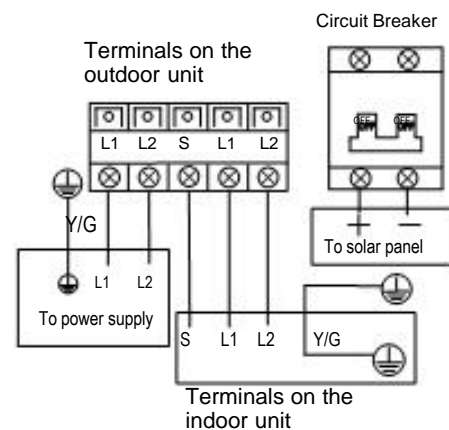

Fig.27

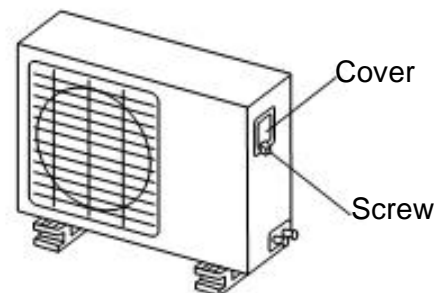

Fig.28

ELECTRICAL WORK

Installation of the solar photovoltaic system

- This guide contains information regarding the installation and safe handling of solar photovoltaic module. All instructions should be read and understood before attempting to install. If there is any question, please contact our sales department for further explanation. The installer should conform to all the safety precautions listed in this guide when installing the module. Local codes should also be followed in such installations.
- This manual describes several typical systems of solar photovoltaic, but does not involve the specific structures and installation procedures of the installation. Please consult the supplier for the information of the following assemblies:
 - a) the specifications of the solar photovoltaic system
 - b) cable material
 - c) connecting components
 - d) bracket and support
 - e) supporting parts
- Before installing a solar photovoltaic system, the installer should become familiar with the mechanical and electrical requirement for such a system. Keep this guide in a safe place for future reference (care and maintenance) and in case of sale or disposal of the module at the end of its useful life.

General

- Installing solar photovoltaic systems may require specialized skills and knowledge. Installation should be performed only by qualified persons.
- All modules come with a permanently attached junction box and #12 AWG terminated in Multicontact PV-KBT4 (female) or PV-KST4 (male) connectors.
- The installer should assume the risk of all injury that might occur during installation, including without limitation, the risk of electric shock.
- The solar photovoltaic electrical energy production system must comply with the following table for suggested current and voltage specifications:

Maximum Power Voltage (W)	$\leq 700W$
Optimum operating voltage (Vmp)	$\leq DC32V$
Optimum operating voltage (Vmp)	$\geq DC20V$
Open-circuit voltage (Vmp)	$\leq DC42V$
Short-circuit current(Vmp)	$\leq DC25A$
Maximum power current(Pmax)	$\leq DC20A$

- One individual module may generate DC voltages greater than 30 volts when exposed to direct sunlight. Contact with a DC voltage of 30V or more is potentially hazardous. Electrical joints such as the wire terminal will cause sparks, burning or deadly electric shock. Please do not touch such terminals directly under any circumstances.



Fig.29

ELECTRICAL WORK

- When disconnecting wires from a photovoltaic module that is exposed to sunlight, an electric arc may result. Such arcs may cause burns, combustion and may otherwise create problems. Therefore, be extremely careful!
- Photovoltaic solar modules convert light energy to direct-current electrical energy. They are designed for outdoor use. Modules may be ground mounted, mounted on rooftops, vehicles, or boats. Proper design of support structures is the responsibility of the system designer and installer. Proper use of mounting holes is suggested in a following paragraph.
- Do not attempt to disassemble the module, and do not remove any attached nameplates or components.



Fig.30

- Do not apply paint or adhesive to module top surface.
- Do not use mirrors or other magnifiers to artificially concentrate sunlight on the module.



Fig.31

- When installing the system, abide with all local, regional and national statutory regulations.
- Obtain a building permit where necessary. Abide with any local and national regulations when mounting on vehicles or boats.

Safety precaution for installing a solar photovoltaic system

- When installing the solar modules or repairing the air conditioner, ensure the circuit breaker on the solar panel of the outdoor unit is in the "OFF" state (push the switch to OFF position).

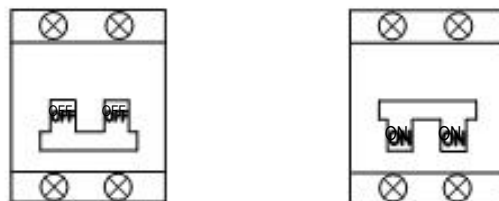

Fig.32

ELECTRICAL WORK

- Solar modules produce electrical energy when light strikes on their front surface. The DC voltage may exceed 30V. If modules are connected in series, the total **voltage** is equal to the sum of the individual module voltages. If modules are connected in parallel, the total **current** is equal to the sum of individual module currents.

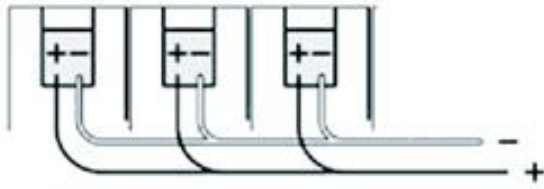

Fig.33

Do NOT Connect in Series. It must be a Parallel Connection.

- Keep children well away from the system while transporting and installing mechanical and electrical components.



Fig.34

- Completely cover the module with a solid material like a blanket during installation to keep electricity from being generated. Do not touch the components or the end of live wires.



Fig.35

- Do not wear metallic rings, watchbands, ear, nose, lip rings or other metallic devices while installing or troubleshooting photovoltaic systems.
- Use only insulated tools that are approved for working on electrical installations.



Fig.36



Fig.37

- Only perform installation in dry conditions.



Fig.38

- Abide with the safety regulations for all other components used in the system, including wiring and cables, connectors, charging regulators, inverters, storage batteries and rechargeable batteries, etc.
- Use only equipment, connectors, wiring and support frames suitable for use in solar electric systems. Always use the same type of module within a particular photovoltaic system.
- The module frame must be properly grounded. The grounding wire must be properly fastened to the module frame to assure good electrical contact. Use the recommended type, or an equivalent, connector for this wire.

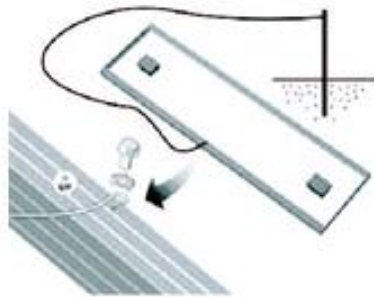

Fig.39

- Under normal outdoor conditions the module will produce current and voltages that are different than those listed in the data sheet. Data sheet values are values expected at standard test conditions. Accordingly, during system design, values of short-circuit current (I_{sc}) and open-circuit voltage (V_{oc}) marked on UL series modules should be multiplied by a factor of 1.25 when determining component voltage ratings, conductor amperage, fuse size and size of controls connected to the module or system output.
- The hole in the back of the module frame is used to drain the water, do not block it.

Mechanical installation

- Select a suitable place for installation of the module. The module should not be shaded at any time of the day.
- The module should be facing due south in northern latitudes and due north in southern latitudes for best power production.
- For detailed information on the best elevation tilt angle for the installation, please consult with the solar photovoltaic system supplier.
- Do not use module near the place where flammable gas may be generated or collected.

ELECTRICAL WORK



Fig.40

2. Selecting the proper support frame

- Always observe the instructions and safety precautions included with the support frame to be used with the module.
- Never attempt to drill holes in the glass surface of the module, it will void the warranty.
- Do not drill additional mounting holes in the frame of the module, it will void the warranty.



Fig.41

- Modules must be securely attached to the mounting structure using four mounting points for normal installation. If additional wind or snow loads are considered for the installation, additional mounting points are also used.
- The support frame must be made of durable, corrosion-resistant and UV-resistant material.
- The heat expansion and cold contraction of the support frame should have no effect on its usage or performance.

3. Ground mount

- Select the height of the mounting system to prevent the lowest edge of the module from being covered by snow for a long time in winter in areas that experience heavy snowfalls. In addition, assure the lowest portion of the module is placed high enough so that it is not shaded by plants or trees or damaged by sand and stone driven by wind.



Fig.42

- When installing a module on a roof or building, ensure that it is securely fastened and cannot fall as a result of wind or snow loads.



Fig.43

- Provide adequate ventilation under a module for cooling (5cm minimum air space between module and mounting surface).



Fig.44

- When installing module on a roof, ensure that the roof construction is suitable. In addition, any roof penetration required to mount the module must be properly sealed to prevent leaks. In some cases, a special support frame may be necessary.
- The roof installation of solar modules may affect the fireproofing of the house construction, so it is necessary to use an earth ground fault circuit breaker. Any improper installation may cause accidental injuries.



Fig.45

- When installing the module on a roof or building, do so in calm winds. Installing a module during strong winds may cause accidents.

5. Pole mount

- When installing a module on a pole, choose a pole and module mounting structure that will withstand anticipated winds for the area. The pole must have a solid foundation.

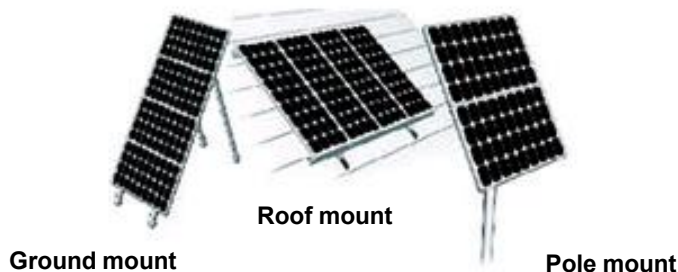

Fig.46

ELECTRICAL WORK

6. General installation

- Module mounting must use the pre-drilled mounting holes in the frame.
- The most common mounting is achieved by mounting the module using the four symmetry points closed to the inner side on the module frame.
- If excessive wind or snow loads are expected, all eight mounting holes must be used.
- If you want to install the module without using the pre-drilled mounting holes in the frame, please consult with the supplier.
- Do not install in the rainy weather, it may cause insulation failure due to moisture, and there is a risk of electric shock.



Fig.47

- Do not attempt to lift the module by grasping the module's junction box while moving.

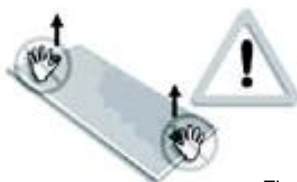

Fig.48

- Do not stand or step on module.



Fig.49

- Do not throw the module or drop any thing on the module.



Fig.50

Do not place any heavy objects on the module. Do not set the module down hard on any surface. Do not scratch or break the glass.



Fig.51

Electrical Installation

1. General installation

- The solar photovoltaic array consists of modules connected in parallel, no more than 3 modules can be used in parallel.

Do not use modules of different configurations in the same system.



- If modules used in the solar photovoltaic system are not the specified brand of the manufacturer, it must comply with the electrical requirement. The cross section area of cable and the capacity of connector must be selected to suit the maximum system short circuit current, otherwise the cable and the connector will be overheated under large current.
- Modules connected in parallel must use a designated switch junction box, please contact the supplier for purchasing. The maximum current of the solar photovoltaic system and the maximum current and voltage capacity of the joints and connective cables should be considered during installation.
- Connection method A: The distance between the modules is close, no need to use the extension cord (3 meters), see Fig.52a.

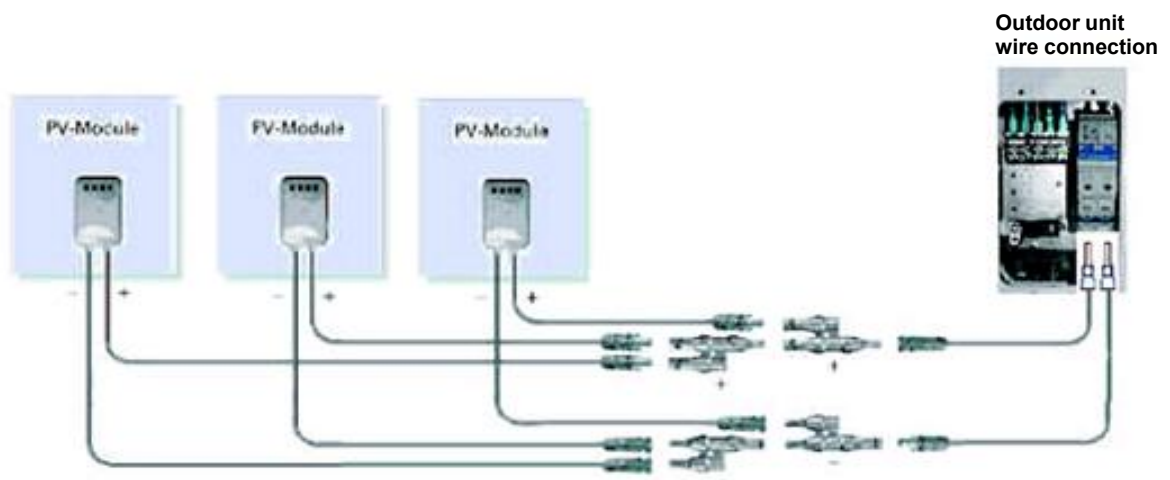

Fig.52a

ELECTRICAL WORK

- Connection method B: Using a 3m extension cord during connection if the modules are distant apart, see Fig.52b.

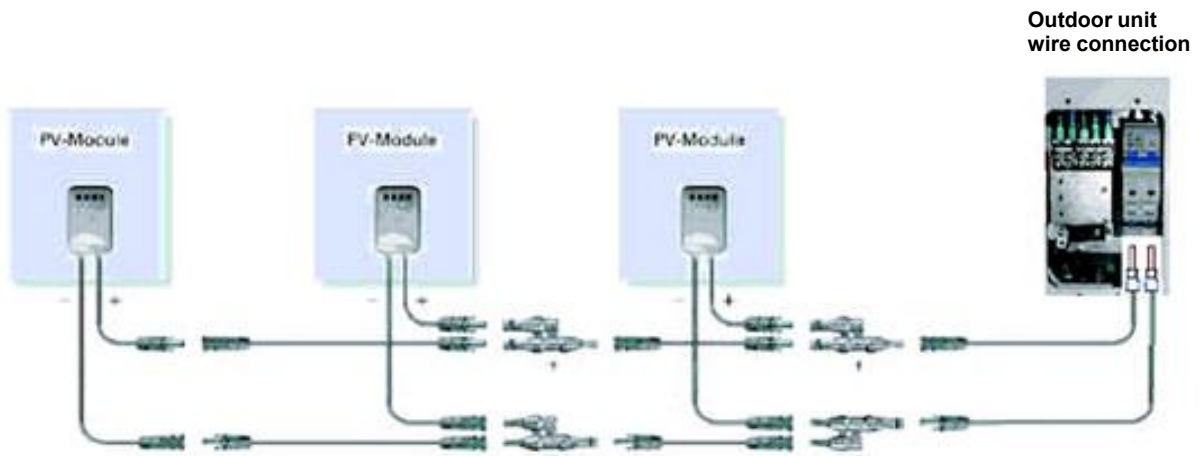

Fig.52b

If you want to connect the photovoltaic modules by using the cables purchased by yourself, the following requirements must be complied:

- Cable installation should comply with all local regional and national regulations.
- In some countries, an individual circuit breaker used between the solar panel and air conditioner must be installed. So select a circuit breaker in accordance with local regulations, and the rated current is more than 30A.
- The electrician must identify the positive pole and negative pole. Reverse connection may cause permanent damage to the air conditioner.
- Use qualified photovoltaic cables only.
- The cable can resist UV rays and climate of rapid change.
- The rated voltage of the cable is more than 600V.
- The cross section area of the cable depends on the maximum short circuit current and the length of wire.
- Be very careful when installing the cable at extremely low temperature.
- Recommended to use the cable of cross section area of 4mm or greater, and the wire should be as short as possible to reduce the energy consumption.
- When the modules are connected in parallel, cables must be securely fastened on the support frame which is used for mounting the modules to avoid wire slack.



Fig.53

- Do not attach the cable on the sharp edge of the frames.



Fig.54

- Attention to the minimum bending radius of the wire.



Fig.55

- Do not unplug the connector when the power is on.



Fig.56

- The protecting sheath must be used on the cable if there is a possibility for animals or children to touch it.



Fig.57

- The manufacturer of the solar photovoltaic system can supply cables suitable for use in solar electric systems.

ELECTRICAL WORK

If you want to use the connector purchased by yourself, the following requirements must be complied:

- Use only connector special designed for solar electric systems.
- Use the recommended or specified tools when install the connectors.
- Do not unplug the connectors when the power is on.
- The connector suitable for the solar photovoltaic system can be obtained from the manufacturer.

Electrical connection:

- Completely cover the module with an opaque material during mechanical installation and electrical Installation.
- Protect the cables from being damaged.
- Ground mounting must abide with all local regulations.
- Storage battery can not be connected with the solar photovoltaic system.

Grounding:

- The module frame must be properly grounded. The grounding wire must be properly fastened to the module frame to assure good electrical contact.
- If the support frame is made of metal, the surface of the frame must be electroplated and have excellent conductivity. The grounding wire must be properly fastened to the support frame .
- There are two pre-drilled mounting holes in the frame, used to install the grounding cable. Each module should connect with the grounding cable.
- We recommend the closed lug when grounding. First insert the ground cable into the jack of the closed lug, then insert the stainless steel bolt (M3) into the tab of the lug, the grounding hole on the frame and finally a nut to secure the entire assembly. The spring washer is required in order to prevent screw loosening and cause improper grounding.
- The grounding resistance must be less than 10 ohms.



Fig.58

Junction box installation:

- All modules come with a permanently attached junction box and provide with fitted cables.
- The junction box is part of the panel itself, please contact the manufacturer if there is any problem with the module.

Disclaimer of liability

Because the use of this manual and the conditions or methods of installation, operation, use and maintenance of photovoltaic (PV) product are beyond our control, we do not take any responsibility and expressly disclaims liability for loss, damage, or expense arising out of or in any way connected with such installation, operation, use or maintenance. No responsibility is assumed by us for any infringement of patents or other rights of third parties, which may resulted by using the PV product. No license is granted by modification or otherwise under any patent or patent rights. The information in this manual is based on company's knowledge and experience and is believed to be reliable; but such information including product specification (without limitations) and suggestions do not constitute a warranty, expressed or implied. We reserves the right to change the manual, the PV product, the specifications, or product data sheets without prior notice.

CAUTION

After complying to the above conditions, prepare the wiring as follows:

- 1) Never fail to have an individual power circuit specifically for the air conditioner. As for the method of wiring, be guided by the circuit diagram posted on the inside of control cover.
- 2) The screws which fasten the wiring in the electrical box are liable to come loose from vibrations which the unit is subjected to during the course of transportation. Check them and make sure that they are all tightly fastened. (If they are loose, it could cause the wires to burn out.)
- 3) Specification of power source.
- 4) Confirm that electrical capacity is sufficient.
- 5) Check that the starting voltage is maintained at more than 90 percent of the rated voltage marked on the nameplate.
- 6) Confirm that the cable thickness is as specified in the power source specification.
- 7) Always install a GFI circuit breaker in a wet or moist area.
- 8) The following could cause a voltage drop:
Vibration of a magnetic switch, which will damage the contact point. Also a bad fuse or breaker could cause a voltage drop.
- 9) The means for disconnection from a power supply shall be incorporated in the fixed wiring and have an air gap contact separation of at least 3mm in each active (phase) conductors.

Evacuation

Air and moisture in the refrigerant system have undesirable effects as indicated below:

- Pressure in the system rises.
- Operating current rises.
- Cooling or heating efficiency drops.
- Moisture in the refrigerant circuit may freeze and block capillary tubing.
- Water may lead to corrosion of parts in the refrigeration system.

The indoor unit and tubing between the indoor and outdoor unit must be leak tested and evacuated to remove any noncondensables and moisture from the system.

Evacuation with vacuum pump

- Preparation

Check that each tube (both liquid and gas side tubes) between the indoor and outdoor units have been properly connected and all wiring for the test run has been completed. Remove the service valve caps from both the gas and the liquid side on the outdoor unit. Note that both the liquid and the gas side service valves on the outdoor unit are kept closed at this stage.

- Pipe length and refrigerant amount:

Lineset pipe length	Air purging method	Additional amount of refrigerant to be charged
Less than 5m	Use vacuum pump.	—————
More than 5m	Use vacuum pump.	R410A: (Pipe length-5)x20g/m

EVACUATION

- When moving the unit to new location, perform evacuation using vacuum pump.
- Make sure the refrigerant added into the air conditioner is liquid form.

Caution in handling the packed valve

- Open the valve stem until it hits against the stopper. Do not try to open it further.
- Securely tighten the valve stem cap with a wrench.
- Valve stem cap tightening torque (See Tightening torque table in previous page).

When Using the Vacuum Pump

(For method of using a manifold valve, refer to its operation manual.)

1. Completely tighten the flare nuts, A, B, C, D, connect the manifold valve charge hose to a charge port of the low-pressure valve on the gas pipe side.
2. Connect the charge hose connection to the vacuum pump.
3. Fully open the LOW valve of the manifold valve.
4. Operate the vacuum pump to evacuate. Check gauge for proper vacuum.
5. Run evacuation for 30 minutes or more and check that the vacuum meter indicates -76cmHg ($-1 \times 10^5\text{Pa}$).
After the evacuation is complete, fully close the LOW valve of the manifold valve and stop the operation of the vacuum pump.
6. Turn the stem of the packed valve B about 45 degrees counter clockwise for 6~7 seconds to purge the line of air, then tighten the flare nut again. Make sure the pressure display in the pressure indicator is a little higher than the atmosphere pressure.
7. Remove the charge hose from the LOW pressure charge port.
8. Fully open the packed valve stems B and A.
9. Securely tighten the cap of the packed valve.

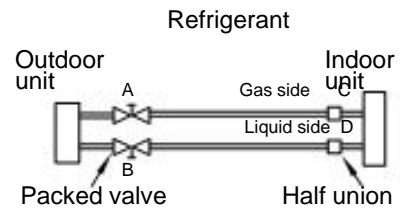

Fig.59

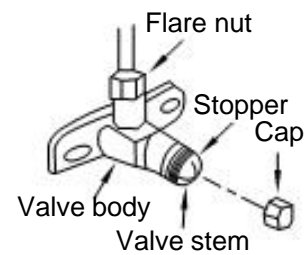

Fig.60

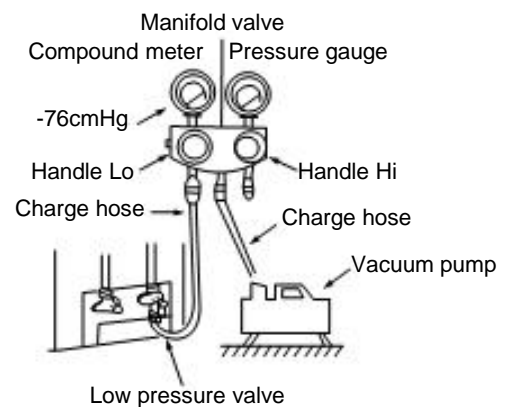

Fig.61

Safety and leakage check

Electrical safety check

Perform the electric safe check after completing installation:

1. Grounding work

After finishing grounding work, measure the grounding resistance by visual detection and grounding resistance tester. Make sure the grounding resistance is less than 4.

2. Electrical leakage check (performing during test running)

During test operation after finishing installation, the serviceman can use the multimeter and probe to perform the electrical leakage check. Turn off the unit immediately if leakage happens. Check and fix before operating the unit.

Gas leak check

1. Soap water method:

Apply a soap water or a liquid neutral detergent on the indoor unit connection or outdoor unit connections by a soft brush to check for leakage of the connecting points of the piping. If bubbles come out, the pipes have leakage.

2. Leak detector

Use the leak detector to check for leakage.

CAUTION

A: Low valve

B: Hi valve

C and D are for indoor unit connection.

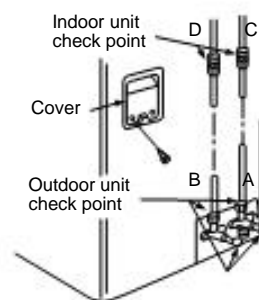

Fig.62

Testing

Perform test operation after completing gas leak check at the flare nut connections and electrical safety check.

- Check that all tubing and wiring have been properly connected.
 - Check that the gas and liquid side service valves are fully open.
1. Connect the power, press the ON/OFF button on the remote controller to turn the unit on.
 2. Use the MODE button to select COOL, HEAT, AUTO and FAN to check if all the functions work well.
 3. When the ambient temperature is too low (lower than 17 C),* the unit cannot be controlled by the remote controller to run at cooling mode, manual operation can be taken. Manual operation is used only when the remote controller is disabled or maintenance is necessary.
 - Press the manual control button on the right side of the panel frame to select the AUTO or COOL, the unit will operate under Forced AUTO or COOL mode.
 4. The test operation should last about 30 minutes.

